

ICOM

INSTRUCTION MANUAL

UHF C.R.S. FM TRANSCEIVER

**IC-40Jr**



Icom Inc.

---

# FOREWORD

---

Thank you for purchasing the IC-40Jr UHF C.R.S. (Citizen Radio Service) FM transceiver. This C.R.S. FM transceiver is designed for those who require top quality, performance and outstanding reliability under the most demanding conditions.

---

## IMPORTANT

---

**READ ALL INSTRUCTIONS** carefully and completely before using the transceiver.

**SAVE THIS INSTRUCTION MANUAL**— This instruction manual contains important operating instructions for the IC-40Jr UHF C.R.S. FM transceiver.

---

## CAUTION

---

**⚠ WARNING! NEVER** hold the transceiver so that the antenna is very close to, or touching exposed parts of the body, especially the face or eyes, while transmitting. The transceiver will perform best if the microphone is held 5 to 10 cm away from your mouth and the transceiver is vertical.

**⚠ WARNING! NEVER** operate the transceiver with a headset or other audio accessories at high volume levels.

**AVOID** using or placing the transceiver in direct sunlight or in areas with temperatures below 0°C or above +55°C

**DO NOT** push the PTT when not actually desiring to transmit.

---

**DO NOT** modify the transceiver for any reason.

**DO NOT** transmit for more than 3 sec., when operating with the group mode and/or call ring function. Transmission in a form other than speech is limited, and should be of a duration of less than 3 sec. as a compliance to ACA requirements in Australia.

The use of non-Icom battery packs/chargers may impair transceiver performance and invalidate the warranty.



**N33**

This device complies with Standard Australia Specification No. AS/NZS4365-1996.

---

## SUPPLIED ACCESSORY

---

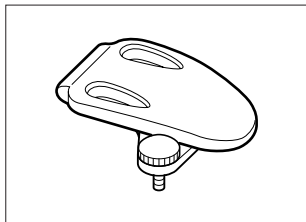

- Belt clip .....1

---

# TABLE OF CONTENTS

---

FOREWORD .....	i
IMPORTANT .....	i
CAUTION .....	i-ii
SUPPLIED ACCESSORY .....	ii
TABLE OF CONTENTS .....	iii
<b>1 ACCESSORY .....</b>	<b>1</b>
<b>2 PANEL DESCRIPTION .....</b>	<b>2-4</b>
■ Switches, controls, keys and connectors .....	2-3
■ Function display .....	4
<b>3 BATTERY PACK .....</b>	<b>5-7</b>
■ Installing batteries in the battery case .....	5
■ Battery pack charging .....	6
■ Battery pack life .....	6
■ Battery pack CAUTION .....	6
■ Charging connections .....	7
<b>4 BASIC OPERATION .....</b>	<b>8-9</b>
■ Power ON .....	8
■ Adjusting the volume .....	8
■ Selecting the operating channel .....	9
<b>5 RECEIVE AND TRANSMIT .....</b>	<b>10-11</b>
<b>6 REPEATER OPERATION .....</b>	<b>12</b>
<b>7 SCAN FUNCTION .....</b>	<b>13</b>
<b>8 GROUP MODE (CTCSS) .....</b>	<b>14-15</b>
■ Setting the group code .....	14
<b>9 RING FUNCTION .....</b>	<b>16</b>
■ Smart-Ring .....	16
■ Call-Ring .....	16
<b>10 OTHER FUNCTIONS .....</b>	<b>17-22</b>
■ Initial set mode .....	17-19
■ ATS (Automatic transponder system) .....	20
■ Auto power save .....	20
■ LCD backlight .....	20
■ Low battery indicator .....	21
■ Resetting the transceiver .....	21
■ Optional HM-75A functions .....	22
<b>11 OPTIONS .....</b>	<b>23</b>
<b>12 SPECIFICATIONS .....</b>	<b>24-25</b>
■ Channel number and group number .....	25
<b>13 WARRANTY .....</b>	<b>26-27</b>

## ■ Accessory attachment

### ◇ Belt clip

Attach the belt clip using the supplied screw.

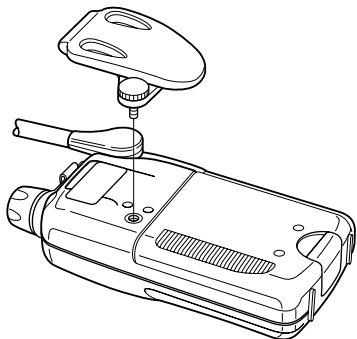

### ◇ Antenna adjustment

Adjust the antenna position as shown in the diagram.

**Keep** the jack cover attached when jacks are not in use to protect from water, dust, etc.

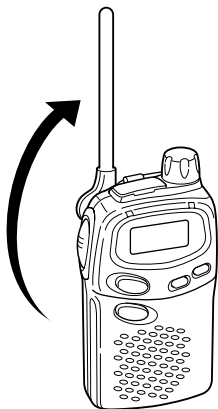

## 2 PANEL DESCRIPTION

### ■ Switches, controls, keys and connectors

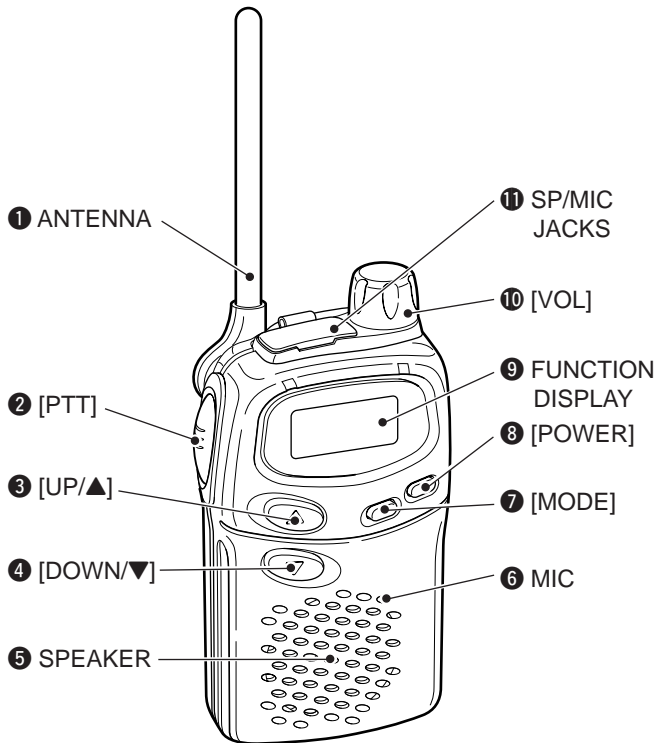

**1 ANTENNA**

Extend the antenna completely when using the transceiver.

- The antenna collapses completely into the transceiver body for carrying purposes.
- The antenna can be adjusted 90 degrees from the regular position when operating the transceiver in a horizontal position.

**2 PTT SWITCH [PTT]**

- Push and hold to transmit; release to receive.

**3 CHANNEL UP SWITCH [UP/▲]**

- Push to change the operating channel up.
- Push and hold to increment the operating channel continuously.
- While scanning, changes scanning direction. (p. 13)

**4 CHANNEL DOWN SWITCH [DOWN/▼]**

- Push to change the operating channel down.
- Push and hold to decrement the operating channel continuously.
- While scanning, changes scanning direction. (p. 13)

**5 SPEAKER****6 MICROPHONE [MIC]****7 MODE SWITCH [MODE]**

- Push to switch between Group mode and Normal mode. (p. 14)
- Push and hold for 1 sec. to open squelch; push and hold for 1 sec. to close it again. (p. 8)

**8 POWER SWITCH [POWER]**

- Push to turn the power ON; push for 1 sec. to turn the power OFF.
- Continue to hold [POWER] down for 2 sec. after power ON to turn the lock function ON and OFF. (p. 18)
- Push to switch between repeater and simplex operation. (p. 12)

**9 FUNCTION DISPLAY (p. 4)****10 VOLUME CONTROL [VOL]**

Rotate clockwise to increase, and counterclockwise to decrease volume.

**11 EXTERNAL SPEAKER AND MICROPHONE JACKS**

Connect an optional speaker-microphone or headset, if desired.

## 2 PANEL DESCRIPTION

### ■ Function display

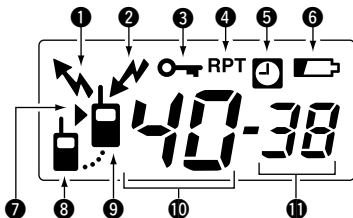

#### ① TRANSMIT INDICATOR

Appears while transmitting.

#### ② BUSY INDICATOR

Appears while receiving a signal or when the squelch is open.

#### ③ KEY LOCK INDICATOR (p. 18)

Appears during key lock function ON.

#### ④ REPEATER INDICATOR (p. 12)

Appears when repeater operation is selected.

#### ⑤ AUTO POWER OFF INDICATOR (p. 17)

Appears while the auto power off function is ON.

#### ⑥ LOW BATTERY INDICATOR (p. 21)

Appears or flashes when battery power has decreased to a specified level.

#### ⑦ PTT HOLD INDICATOR (p. 19)

- Appears when the "PTT hold" function is turned ON.
- Flashes while transmitting.

#### ⑧ ANSWER BACK INDICATOR (p. 20)

- Appears when you and your group are in the conversation area.
- Flashes when you or your group are out of the conversation area.

#### ⑨ POWER ON INDICATOR

Appears while the power is ON.

#### ⑩ CHANNEL NUMBER INDICATOR

Indicates operating channel number.

#### ⑪ GROUP NUMBER INDICATION (p. 14)

One of 01 to 38 appears while the Group function is turned ON.



# BATTERY PACK 3

## ■ Installing batteries in the battery case

Install 3 AA size alkaline, dry cell batteries or the optional BP-202 BATTERY PACK as illustrated below.

- ① Remove the battery case cover from the transceiver.

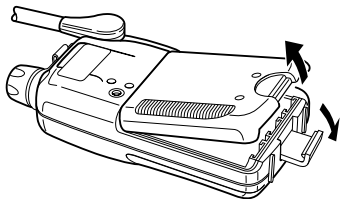

- ② Install 3×AA size alkaline, dry cells, or the BP-202.  
• Be sure to observe the correct polarity.

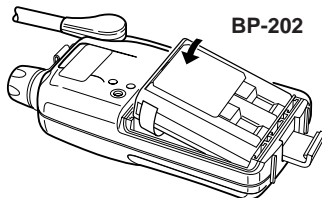
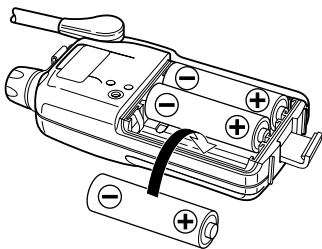

**NOTE:** Keep battery contacts clean. It's a good idea to clean battery terminals once a week.

---

### 3 BATTERY PACKS

## ■ Battery pack charging

The optional BP-202 BATTERY PACK includes rechargeable Ni-Cd batteries and can be charged approx. 300 times. Charge the battery pack before first operating the transceiver or when the battery pack becomes exhausted.

If you want to be able to charge the battery pack more than 300 times, the following points should be observed:

1. Avoid overcharging. The charging period should be less than 48 hours.
2. Use the battery until it becomes almost completely exhausted under normal conditions. We recommend battery charging just after transmitting becomes impossible.

## ■ Battery pack life

If your battery pack seems to have no capacity even after being fully charged, completely discharge it by leaving the power ON all day. Then, fully charge the battery pack again.

If the battery pack still does not retain a charge (or very little), a new battery pack must be purchased.

## ■ Battery pack CAUTION

**NEVER** short the terminals of the battery pack (or charging terminals of the transceiver). Also, current may flow into nearby metal objects, so be careful when placing battery packs (or the transceiver) in handbags, etc. Simply carrying with metal objects may cause a short circuit. This will damage not only the battery pack but also the transceiver.

## ■ Charging connections

### ◇ Rapid charging with the BC-119+AD-89

- ① Insert the optional AD-89 DESKTOP CHARGER ADAPTER into the charging slot of the BC-119.
- ② Insert the battery pack, either by itself or attached to the transceiver, into the charger.

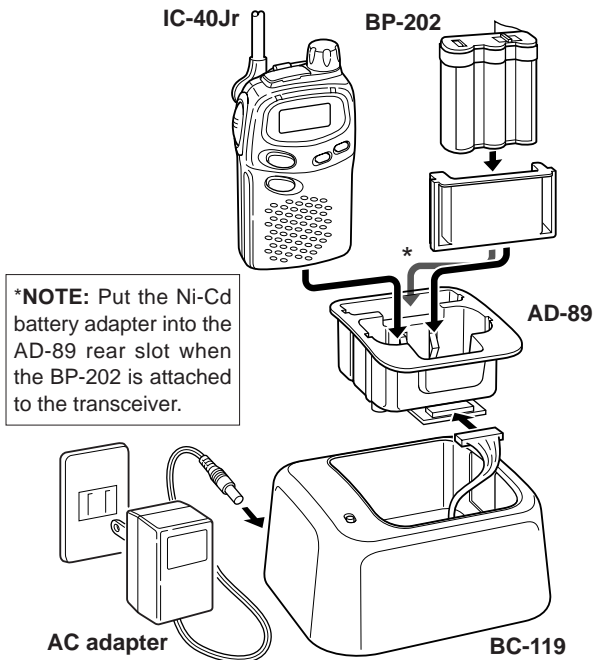

# 4 BASIC OPERATION

## ■ Power ON

- ➔ Push [POWER] for 1sec. to turn the power ON.
  - The power on indicator and operating channel number appear in the display.

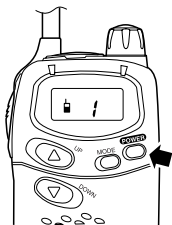

## ■ Adjusting the volume

- ① Push [MODE] for 1 sec. to open the squelch.
  - The busy indicator appears in the display while the squelch is open.
- ② Adjust the audio to a suitable level using [VOL].
- ③ Push [MODE] for 1sec. to close the squelch.

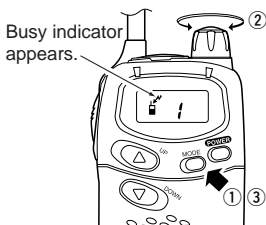

### ✓ *What is squelch?*

A squelch circuit allows you to mute undesired noise while receiving no signal and emit audio while receiving signals.

This provides quiet standby. The [MODE] key changes the squelch setting. This is useful to listen to weak signals that do not open the squelch.

## ■ Selecting the operating channel

Push [UP/▲] or [DOWN/▼] keys several times until the desired operating channel number appears in the display.

- While pushing and holding [UP/▲] or [DOWN/▼] keys, the displayed channel changes continuously until channel number “1” appears.
- When the displayed channel stops at channel number “1”, a confirmation beep is emitted.



### NOTE:

- The transceiver has 40 operating frequency channels.
- The selected channel is memorised when you turn off the transceiver.
- The transceiver has an auto power save function to conserve the battery power. The power save function activates automatically when no signal is received for 5 sec., or 5 sec. after key operation is completed.

# 5

## RECEIVE AND TRANSMIT

- ① Push [MODE] for 1 sec. to open the squelch.
  - Adjust volume to the desired audio level. (See p. 8)
- ② Select a desired operating channel. When a signal is received:
  - “↗” appears in the display.
  - Squelch opens and audio is emitted from the speaker.
  - Further adjustment of [VOL] may be necessary at this point.
- ③ Push and hold [PTT] to transmit then speak into the microphone.
  - Do not hold the transceiver too close to your mouth or speak too loudly. This may distort the signal.
  - The transmit indicator “↘” appears in the display.
- ④ Release [PTT] to return to receive.

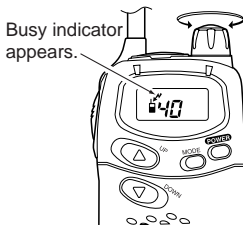

### Time-Out Timer (TOT)

The transceiver has a time-out timer function. This function prevents continuous, extended transmissions. This timer turns the transmission OFF 3 min. after it starts.

A warning beep sounds 10 sec. before the limit is reached, and the time-out timer turns OFF the transmission automatically. Another beep sounds to announce the end of the transmission.

**✓ Talk Range**

The IC-40Jr is designed to maximize performance and improve transmission range in the field. However, the single most important factor in transmit range is your surrounding environment. These radios are “line of sight” radios and as such, transmission range is influenced by the degree to which you can “see” the other communicating party. Large concrete structures and heavy foliage or transmission from inside a building or vehicle will reduce your talk range.

- Optimal range : wide, open areas free of obstructions.
- Medium range : large buildings or trees blocking your line of sight.
- Minimum range : mountainous areas or areas of heavy foliage.

# 6 REPEATER OPERATION

A repeater amplifies received signals and re-transmits them on a different channel, allowing you to communicate over greater distances with improved reliability. When using a repeater, the transmit channel is shifted from the receive channel by 30 channels. Please ask your dealer regarding repeater availability in your local area.

- ① Push [UP/▲] or [DOWN/▼] to select the desired channel from 1 to 8.
  - If group code appears next to the operating channel number, push [MODE], then select “ --- ” with [UP/▲] or [DOWN/▼] to cancel the group mode (p. 14).

**⚠ WARNING!**

As group mode is not compatible with repeater operation, no audio will be heard.

- ② Push [POWER] momentarily to set repeater mode.
  - “RPT” appears in the display.
  - The duplex setting affects the selected channel only and the setting is retained after channel selection.
- ③ Push and hold [PTT] to transmit.
  - The displayed channel automatically changes to the transmit channel (repeater input channel).

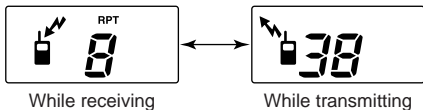

- ④ Release [PTT] to receive.
- ⑤ To cancel the duplex setting, push [POWER] momentarily on the desired channel.

Repeater indicator appears.

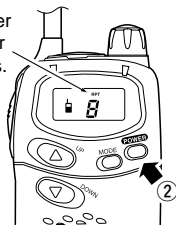



# SCAN FUNCTION 7

Scanning is an efficient way to locate signals quickly over all channels. Select scan resume condition in advance, using Initial Set Mode (p. 18)

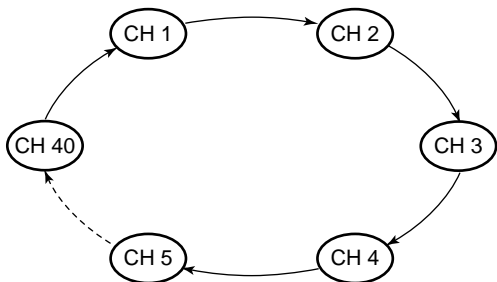

## ◇ Starting the scan

- ➔ While pushing [UP/▲], push [DOWN/▼] to start the scan.
  - “-” flashes.
  - While pushing [DOWN/▼], pushing [UP/▲] also starts the scan.
  - Push [DOWN/▼] or [UP/▲] to change the scanning direction or resume the scan manually.
  - To cancel the scan, push [DOWN/▼] (or [UP/▲]) while [UP/▲] (or [DOWN/▼]) is pushed, or push [PTT].



# 8 GROUP MODE (CTCSS)

## ■ Setting the group code

The IC-40Jr is equipped with 38 group codes. Group mode operation provides communication with silent standby since you will only receive calls from group members using the same group number.

First of all, set the same group code number for all group member's transceivers.

### **To turn ON the group mode operation:**

- ① Push [MODE] to enter set mode.
  - Operating channel number disappears and “ --- ” (group mode OFF) appears in the display.
- ② Push [UP/▲] or [DOWN/▼] to select the desired code number.
- ③ Push [MODE] to set the group code number.

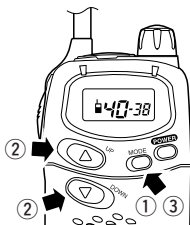

### **To cancel the group mode operation:**

- ① Push [MODE] to enter set mode.
  - Operating channel number disappears from the display.
- ② Push [UP/▲] or [DOWN/▼] to select “ --- ” (group mode OFF).
- ③ Push [MODE] to cancel the group mode.

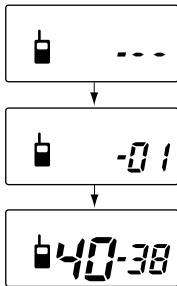

**IMPORTANT!** Before transmitting, make sure the channel you will operate with the group mode is clear by pushing [MODE] for 1 sec., to prevent interference to other stations.

**NOTE:** Only stations with the same group channel number can be heard during group mode operation, even when the busy indicator appears in the display.

✓ **What is CTCSS (Continuous Tone Coded Squelch System) GROUP MODE ?**

CTCSS (Continuous Tone Coded Squelch System) GROUP MODE allows communication with silent stand by. Only signals containing your group code can open the squelch.

This conveniently eliminates unwanted audio and is useful in group activities or security related activities where unwanted output can be a problem. Note that CTCSS group mode is not private— anyone can receive your calls.

The IC-40Jr is equipped with 38 tone codes for CTCSS GROUP MODE use. Selecting a code applies to all 40 operating channels. Each push of [PTT] superimposes your group code over your transmit signal; and, only signals containing the same code can open your squelch. To temporarily hear all signals (including noise) push and hold [MODE]. Do not use CTCSS GROUP MODE if you want to be able to hear all signals on the channel.

◇ **CTCSS code table**



Code	Freq.	Code	Freq.	Code	Freq.	Code	Freq.
01	67.0	11	97.4	21	136.5	31	192.8
02	71.9	12	100.0	22	141.3	32	203.5
03	74.4	13	103.5	23	146.2	33	210.7
04	77.0	14	107.2	24	151.4	34	218.1
05	79.7	15	110.9	25	156.7	35	225.7
06	82.5	16	114.8	26	162.2	36	233.6
07	85.4	17	118.8	27	167.9	37	241.8
08	88.5	18	123.0	28	173.8	38	250.3
09	91.5	19	127.3	29	179.9	---	OFF
10	94.8	20	131.8	30	186.2		

(unit: Hz)

# 9 RING FUNCTION

## Smart-Ring

The Smart-Ring function has an answer back feature. This allows you to confirm whether or not a call has reached the receiving party.

- ① Set the same group code number for all of your group transceivers. (See p. 14)
- ② While pushing [PTT], push [UP/▲].
  - A beep is emitted and “” flashes in the display.
- ③ Release the [PTT].
  - When a member of your group answers your call, the transceiver emits beep tones for 10 sec. and “” stops flashing.
  - When no answer comes back, the transceiver emits short faint beep tones.
- ④ Push [PTT] to answer and to stop the beeps and flashing.



**NOTE:** This function is available only when the called station has set the same group number and the same operating channels as you.

## Call-Ring

Sends the ring tones during transmit mode.

- While pushing [PTT], push [DOWN/▼] to send a ring tone.
- The ring tone is emitted while pushing [DOWN/▼].
  - The microphone signal is automatically cut while pushing [DOWN/▼].



## ■ Initial set mode

Initial set mode is accessed at power ON and allows you to set seldom changed settings. In this way you can “customise” the transceiver operations to suit your preferences and operating style.

### ◇ Auto power OFF

This function sets the transceiver to automatically turn OFF after 2 hours has elapsed from the last key operation.

- ① While pushing [MODE], push [POWER] ON to switch the function ON or OFF.
- ② “” appears in the display.
  - “Auto power OFF” function retains its setting after power OFF.



### ◇ Ring tone type

You can select the ring tone from one of 10 sounds.

- ① While pushing [UP/▲], push [POWER] ON.
- ② Push [UP/▲] or [DOWN/▼] to select the ring sound.

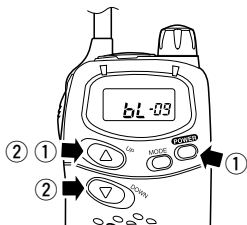

### ◇ Beep tones ON/OFF

Confirmation beep tones normally sound when you push a key. These can be turned ON or OFF.

- ➔ While pushing [DOWN/▼], push [POWER].

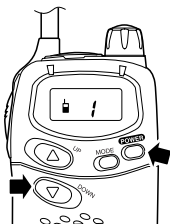

## 10 OTHER FUNCTIONS

### ◆ Lock function

This function electronically locks all keys and switches to prevent accidental channel changes and function access.

- ➔ Continue to hold [POWER] down for 2 sec. after power ON to turn the lock function ON and OFF.

“” appears in the display.

- Only [POWER], [MODE] and [PTT] are functional.
- The Ring function is also available. (See p. 16)

Lock indicator appears.



### ◆ Scan resume condition

The scan resume condition can be selected from timer and pause scan. When the pause scan (P-05) is selected, this pauses the scan until 5 sec. has passed after the signal has disappeared. When the timer scan (t-05) is selected, this pauses for 5 sec. and then resumes, even if a signal is being received on the channel.

- ① While pushing both [UP/▲] and [DOWN/▼], turn the power ON.
- ② Push [UP/▲] or [DOWN/▼] to select scan resume condition from t-05 and P-05.  
(Default setting is t-05.)

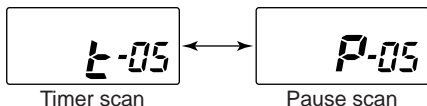
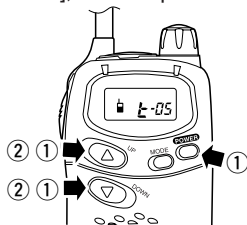

### ◇ PTT hold function

This function frees you from having to constantly push [PTT] during conversation.

① While pushing [PTT], turn the power ON to switch the PTT hold function ON and OFF.

- “▶” appears in the display when the PTT hold function is activated.
- During group mode operation, the PTT hold function cannot be activated. Push [MODE] to cancel the group mode (p. 14).

② Push [PTT] to transmit.

- “↖” appears and “▶” flashes in the display.
- Once [PTT] is pushed, it is not necessary to hold [PTT] any longer during transmission.
- The transmission is automatically cancelled when the time-out timer is activated (p. 10).

③ Push [PTT] to return to receive.

- “↖” disappears and “▶” stops flashing.

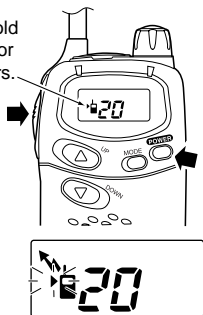

PTT hold indicator appears.



/// **NOTE:** The PTT hold function cannot be activated with the external speaker-microphone's [PTT].

### ■ ATS (Automatic Transponder System)

This allows you to confirm whether or not a call has reached the receiving party even if the operator is temporarily away from the transceiver. No “Ring” tone is emitted with this function.

- ➔ Push [MODE], while [PTT] is ON to turn the function ON/OFF.
  - “” appears in the display.
  - The transceiver starts to send a search signal every 60 sec.
    - When the transceiver receives an answer back signal, “” stays on the display until the next search transmit.
    - If no reply is received, “” flashes until the next search transmit.

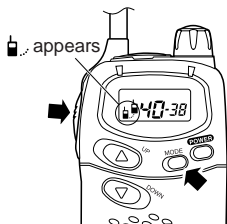

**NOTE:** The above setting is for the calling station only. A called party automatically sends an answer back signal without any presettings.

All IC-40Jr's operating on the same operating channel will answer back to your call in your communication area.

### ■ Auto power save

- ➔ The power save function reduces the current drain to conserve battery power.
  - The function automatically starts when no operation is performed or no signal is received for 5 sec.

### ■ LCD backlight

- ➔ Automatically lights ON for 5 sec. when you push any key, except [PTT].



## ■ Low Battery indicator

- ➔ Appears when the battery is nearing exhaustion.
  - A warning beep is emitted at power ON.
- ➔ Appears and flashes when battery replacement is necessary.

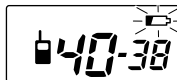
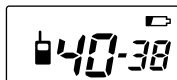

## ■ Resetting the transceiver

Initialise the operating conditions before using the transceiver for the first time, or if the function display shows erroneous information.

- ➔ While pushing [DOWN/▼] and [MODE], push [POWER] ON to initialise the transceiver.

**CAUTION:** Resetting the transceiver returns all settings to their defaults.





## 10 OTHER FUNCTIONS

### ■ Optional HM-75A functions

The optional HM-75A allows you to remotely select operating channels, open the squelch, etc. The switches on the HM-75A function as follows.

**CAUTION:** When connecting the HM-75A to the transceiver, make sure that power to the transceiver is turned OFF, otherwise the transceiver may malfunction.

#### ◇ Switch action

SWITCH	NORMAL	While holding [PTT]
<b>A</b>	Smart-Ring	No function
<b>B</b>	Open squelch	No function
<b>UP</b> 	Change the operating channel number up.	Smart-Ring
<b>DOWN</b> 	Change the operating channel number down.	Call-Ring

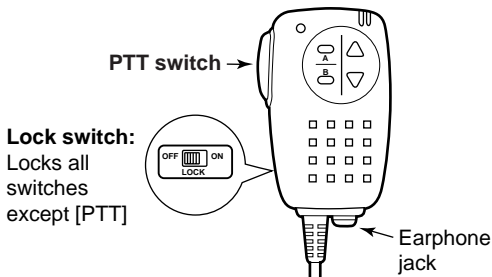

## ◇ Battery pack

### **BP-202** Ni-Cd BATTERY PACK

3.6V/700 mAh rechargeable battery pack, allows approx. 10 hours of operation. (pgs. 6–7)

## ◇ Charger

### **BC-119** DESKTOP CHARGER + **AD-89** DESKTOP CHARGER ADAPTER

Rapidly charge battery packs in 1 to 1.5 hrs. An AC adapter is packed with the BC-119. The AD-89 must be used with the BC-119 for charging the battery pack. The CP-17L CIGARETTE LIGHTER CABLE WITH NOISE FILTER OR OPC-515L DC POWER CABLE can be used instead of the supplied AC adapter. (p. 7)

## ◇ Speaker-microphones

**HM-46**



**HM-54**

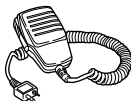

**HM-75A**



Remote control capability.  
(see p. 22 for details)

**HS-85** HEADSET



- PTT switch
- VOX
- One-touch PTT for hands-free operation

## ◇ Cables (for the BC-119)

**CP-17L**



**OPC-515L**

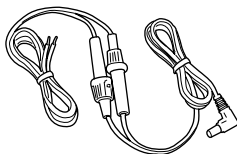

# 12 SPECIFICATIONS

## GENERAL

- Frequency coverage : 40 UHF C.R.S. channels  
(476.425–477.400 MHz)
- Mode : F3E (FM)
- Frequency stability :  $\pm 3.0$  kHz
- Frequency resolution : 25 kHz
- Power supply requirement: 4.5 V (AA  $\times$  3) or BP-202
- Current drain : Less than 500 mA
- Battery life (Tx:Rx:Stand-by=1:1:8):
  - 3 Alkaline cells : approx. 28 hours
  - Optional BP-202 : approx. 10 hours
- Operating temp. range : 0°C to +55°C
- Number of CTCSS freq. : 38
- Dimensions : 55.5(W) $\times$ 102.5(H) $\times$ 26.5(D) mm  
(projections not included)
- Weight : 180 g (including 3 AA batteries)

## TRANSMITTER

- Output power : 500 mW  $\pm 20\%$  (at 4.5 V DC)
- Maximum deviation : Less than  $\pm 5.0$  kHz
- Spurious emissions : Less than  $-30$  dBm
- Ext. mic. connector : 3-conductor 2.5 (d) mm/2.2 k $\Omega$

## RECEIVER

- Receive system : Double-conversion superheterodyne
- Sensitivity : Less than 0.2  $\mu$ V (12 dB SINAD)
- Selectivity : More than 12 kHz/ $-6$  dB
- Spurious and image rejection: More than 40 dB
- Adjacent Ch. rejection : More than 40 dB
- Intermodulation rejection : More than 40 dB
- Audio output power : More than 100 mW at 10% distortion  
(at 4.5 V DC) with an 8  $\Omega$  load
- Ext. speaker connector : 2-conductor 3.5 (d) mm/8  $\Omega$

All stated specifications are subject to change without notice or obligation.

### ◇ Channel frequency list

CH	Freq.	CH	Freq.	CH	Freq.	CH	Freq.
1	476.425	11	476.675	21	476.925	31	477.175
2	476.450	12	476.700	22	476.950	32	477.200
3	476.475	13	476.725	23	476.975	33	477.225
4	476.500	14	476.750	24	477.000	34	477.250
5	476.525	15	476.775	25	477.025	35	477.275
6	476.550	16	476.800	26	477.050	36	477.300
7	476.575	17	476.825	27	477.075	37	477.325
8	476.600	18	476.850	28	477.100	38	477.350
9	476.625	19	476.875	29	477.125	39	477.375
10	476.650	20	476.900	30	477.150	40	477.400

(Unit: MHz)

## ■ Channel number and group number

Use this page to record your group operating channel number (p. 9) and group channel number (p. 14) for your reference.

<b>Operating channel number</b>	
<b>Group code number</b>	

# 13 WARRANTY

## Icom Warranty

Icom Incorporated is proud of the technology within, and the quality of workmanship of its products.

**Icom (Australia) Pty. Ltd.**, the authorised Icom Distributor, warrants this Icom product to be free defects in material or workmanship for a period of two years from date of purchase from an authorized Icom dealer.

Icom (Australia) Pty. Ltd. will, at its discretion, and subject to the terms and conditions stated below, repair or replace any goods or component part thereof which its examination shall disclose to be defective.

Unless otherwise expressly provided, any fault arising from defective workmanship or material shall be rectified by Icom where the equipment is returned freight prepaid to Icom at 290–294 Albert Street, Brunswick Victoria 3056 within **twenty four months** of the date of purchase of the goods, proof of purchase must be presented.

This Warranty shall not apply:

- (a) To an Icom product which has failed due to improper installation, misuse, accident, alteration or unauthorized repair or modification.
- (b) If any serial number or identification place attached to the goods has been altered, rendered illegible, or removed.
- (c) If the goods have been:
  - (i) subject to misuse, abuse, or negligent or accidental damage;
  - (ii) connected to improper, inadequate or faulty power including reverse polarity;
  - (iii) operated otherwise than in accordance with the instructions furnished by Icom;
  - (iv) damaged by corrosion, deterioration or by abnormal temperatures; the influence of foreign matter or energy of physical or chemical properties of water, steam or chemical compounds;
  - (v) serviced, repaired or disassembled whether wholly or in part other than by Icom (Australia) Pty. Ltd.;
  - (vi) purchased from any dealer other than an authorised Icom dealer.
- (d) If no proof of purchase is presented.

This Warranty is in addition to the benefits conferred by Federal and State legislation and, to the extent allowed thereunder and without in any way limiting and implied warranty of merchantability or fitness for a particular purpose, any liability of Icom for any loss or damage arising from breakdown, failure to perform or illegal use is hereby expressly excluded.

## WARRANTY SERVICE INSTRUCTION

1. If you have difficulty, send your equipment to Icom (Australia) Pty. Ltd., preferably in the original carton, without accessories, prepaid, with a brief explanation of the difficulty you have experienced.
2. Include accessories only if your specific situation indicates an accessory related difficulty exists, otherwise Icom (Australia) Pty. Ltd. shall assume no liability for the loss or safe return of an accessory item. Itemise these accessories on the note of explanation.
3. If the requested repairs or services are within the terms of the warranty, your equipment will be returned after repair, to any designated point within Australia.
4. If the requested repairs or services are not within the terms of the warranty, or if you fail to provide acceptable evidence of date of purchase or proof of purchase, return freight will be charged.

Model : **IC-40Jr**

---

Date of purchase :

---

Serial Number :

---

Dealer Name :

---

### Authorized Icom Distributor

Icom (Australia) Pty. Ltd. A.B.N. 88 006 092 575  
290-294 Albert Street,  
Brunswick 3056 Vic.

**Count on us!**

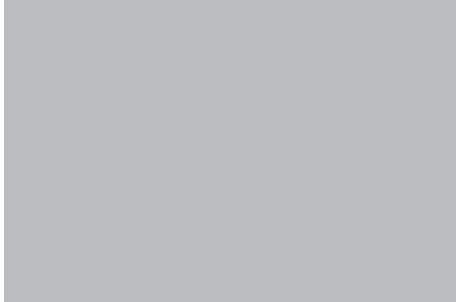

A-5691D-1AU  
Printed in Japan  
© 2000 Icom Inc.

**Icom Inc.**  
1-1-32 Kamiminami, Hirano-ku, Osaka 547-0003 Japan